

29-04-001 , Engine Control 2,9 I V6 24V EFI , Ignition

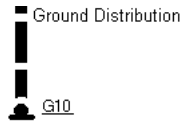

29-04-002 , Engine Control 2,9 I V6 24V EFI , Ignition

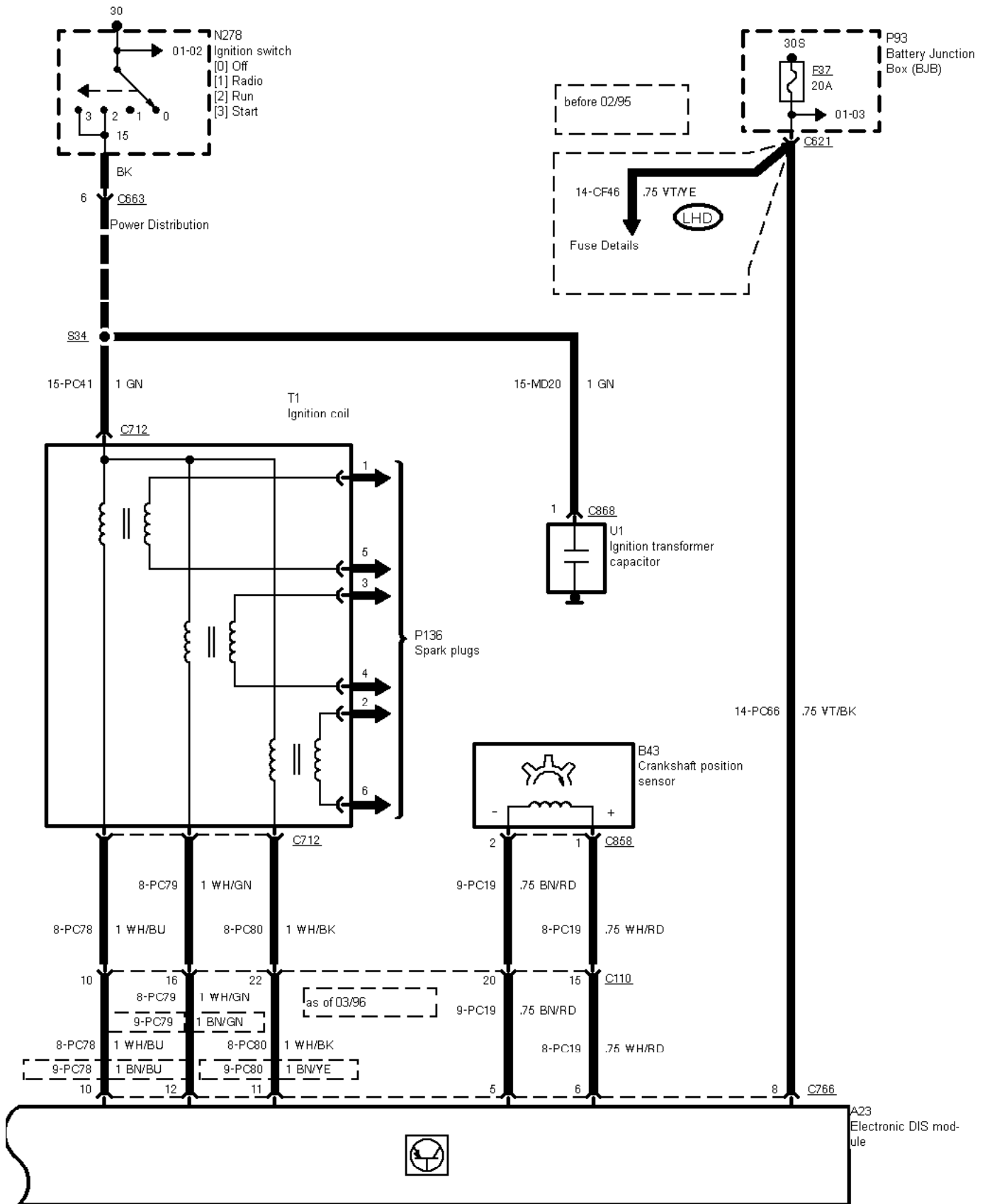
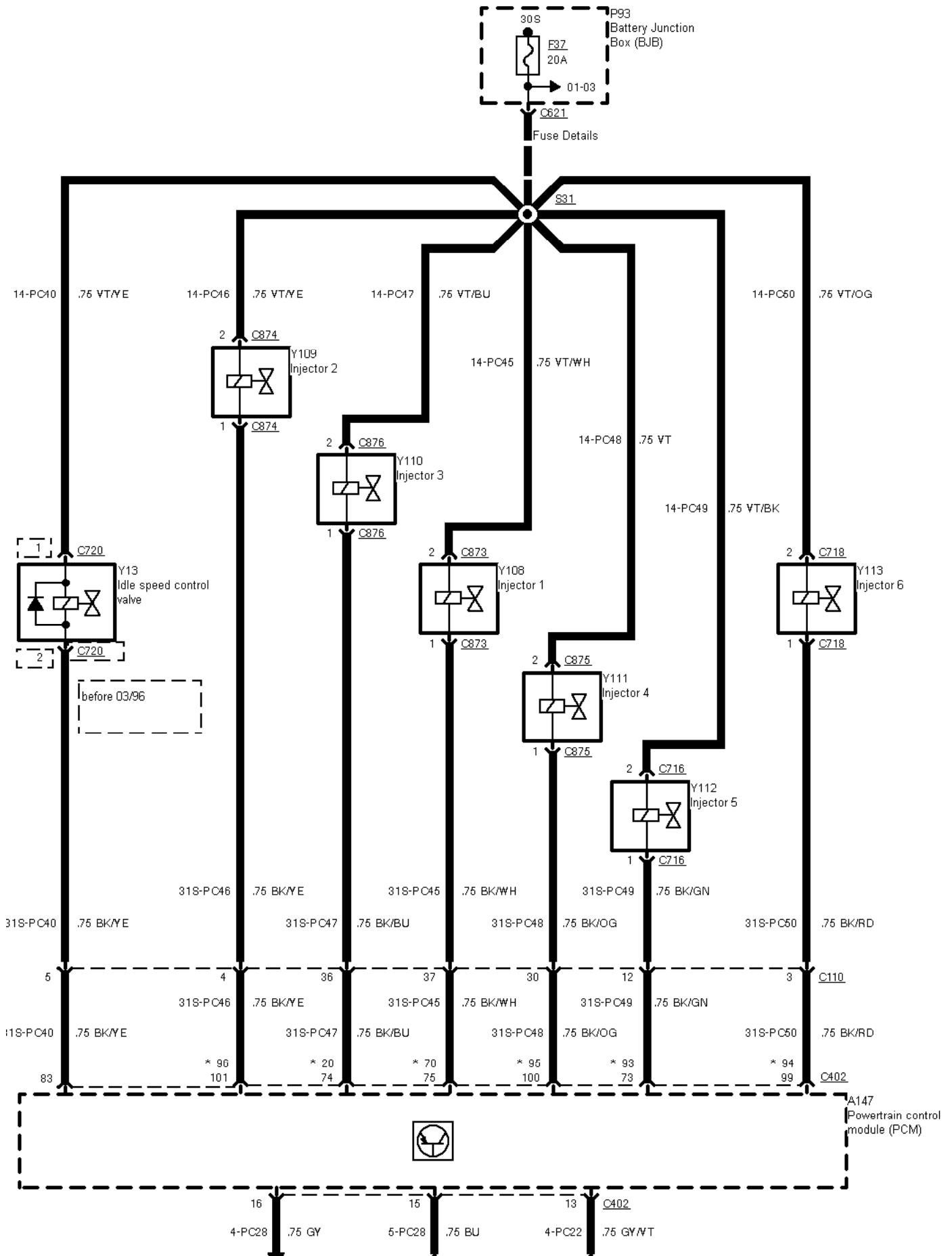

29-04-003 , Engine Control 2,9 I V6 24V EFI , Fuel injectors



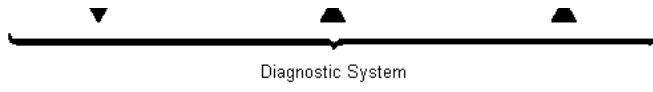

* with PATS

29-04-004 , Engine Control 2,9 I V6 24V EFI

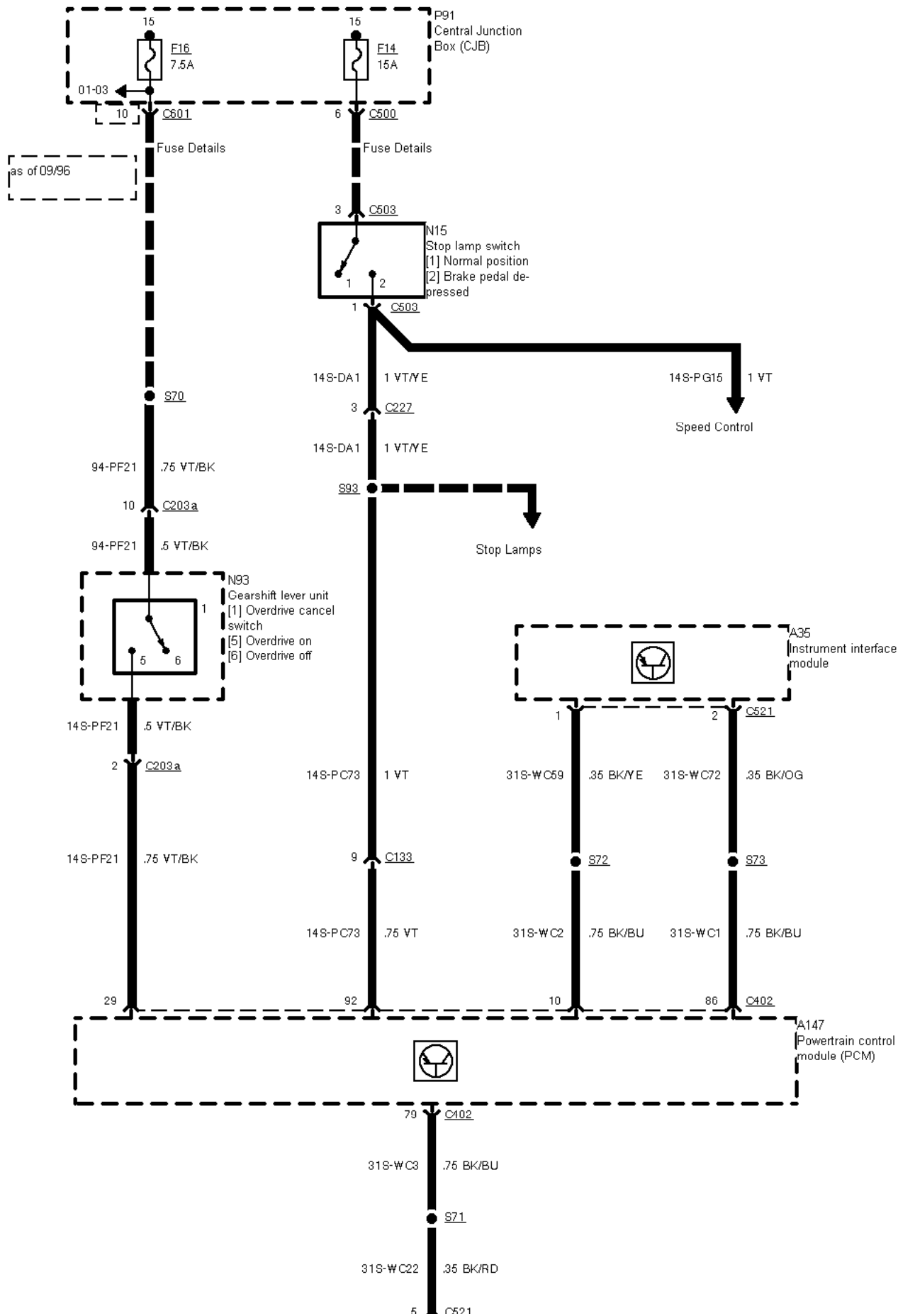

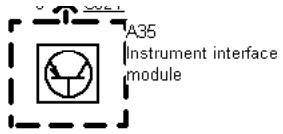

29-04-005 , Engine Control 2,9 I V6 24V EFI , Sensors

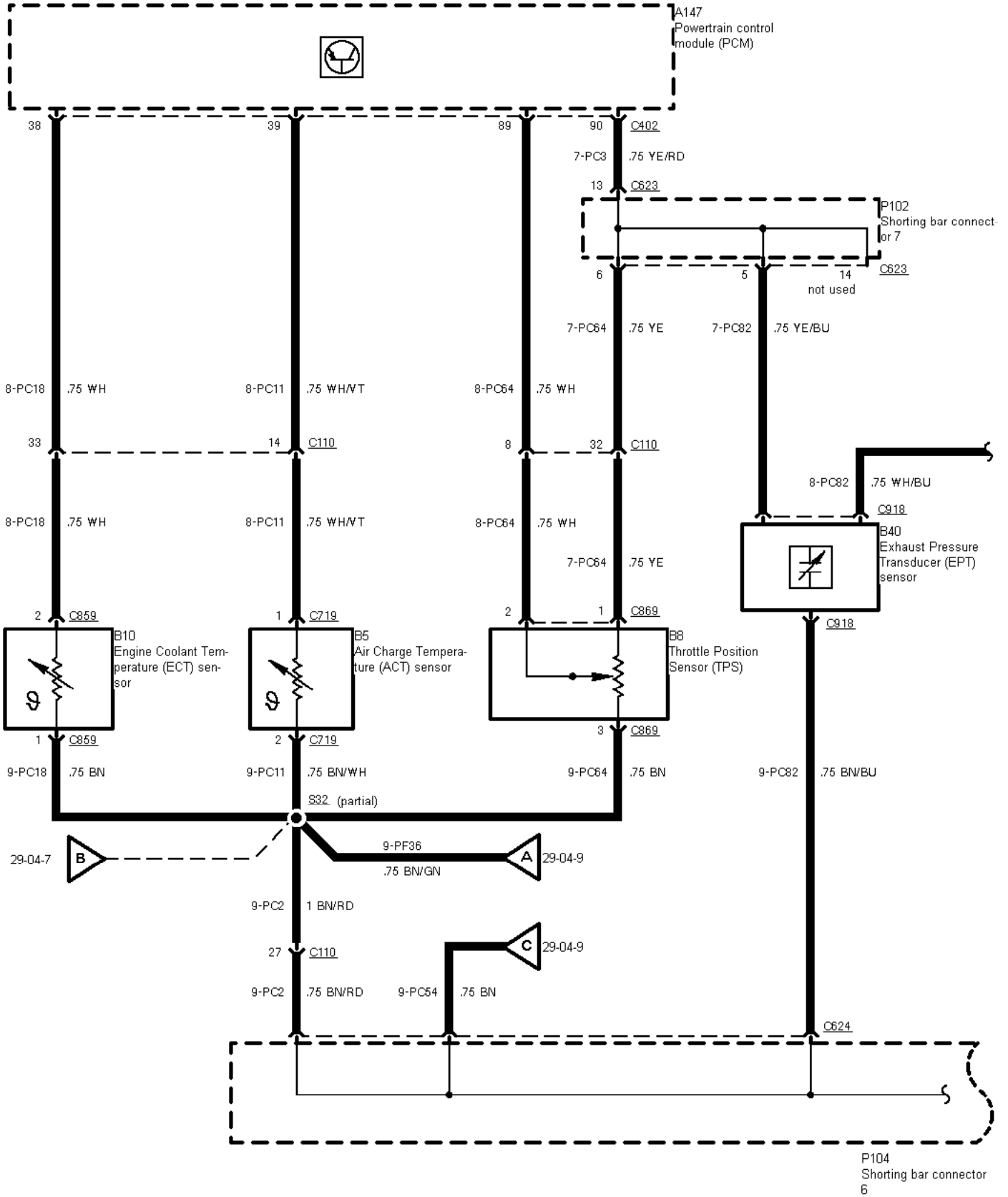

29-04-006 , Engine Control 2,9 I V6 24V EFI

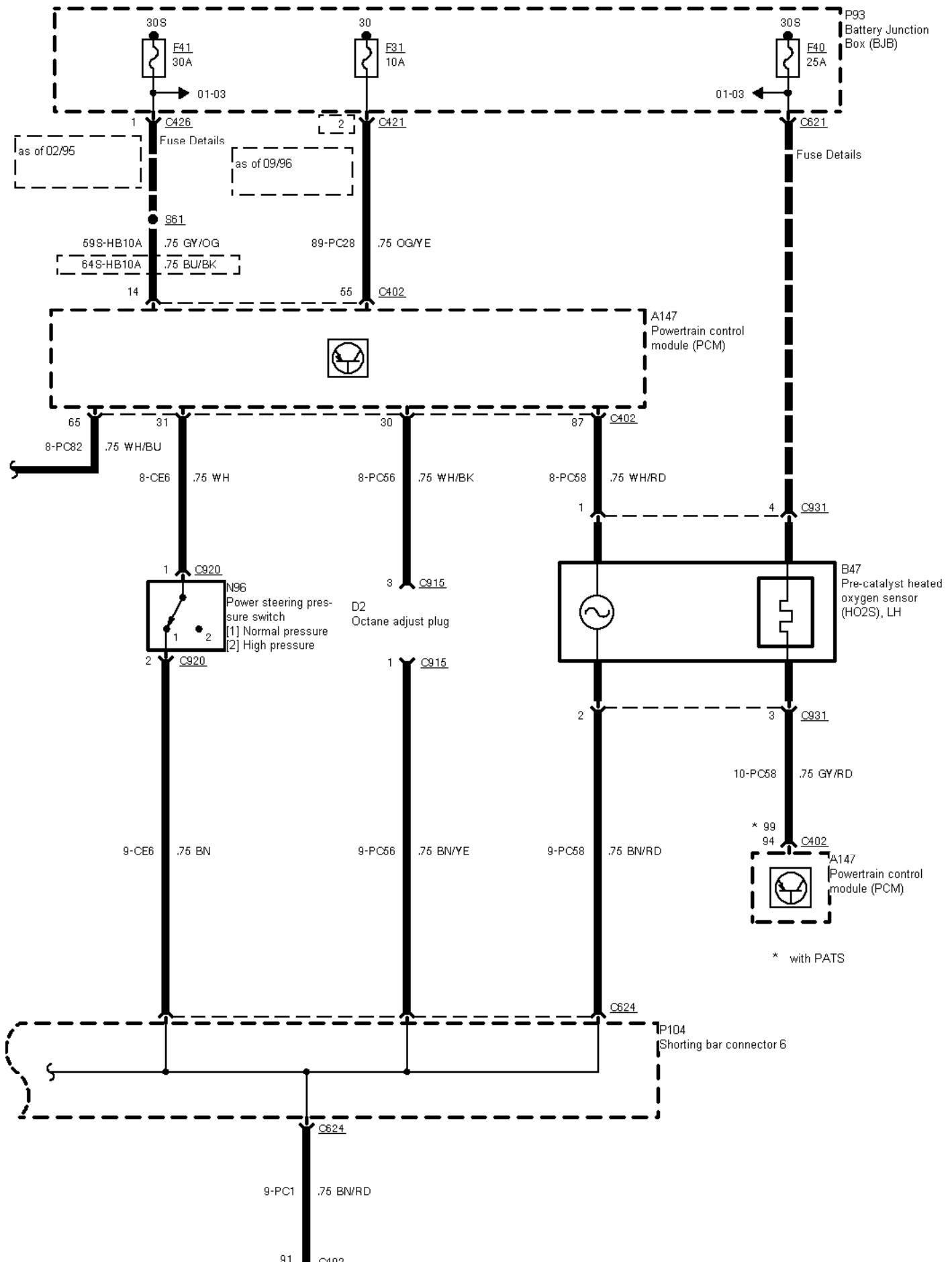

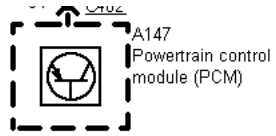

29-04-007 , Engine Control 2,9 I V6 24V EFI

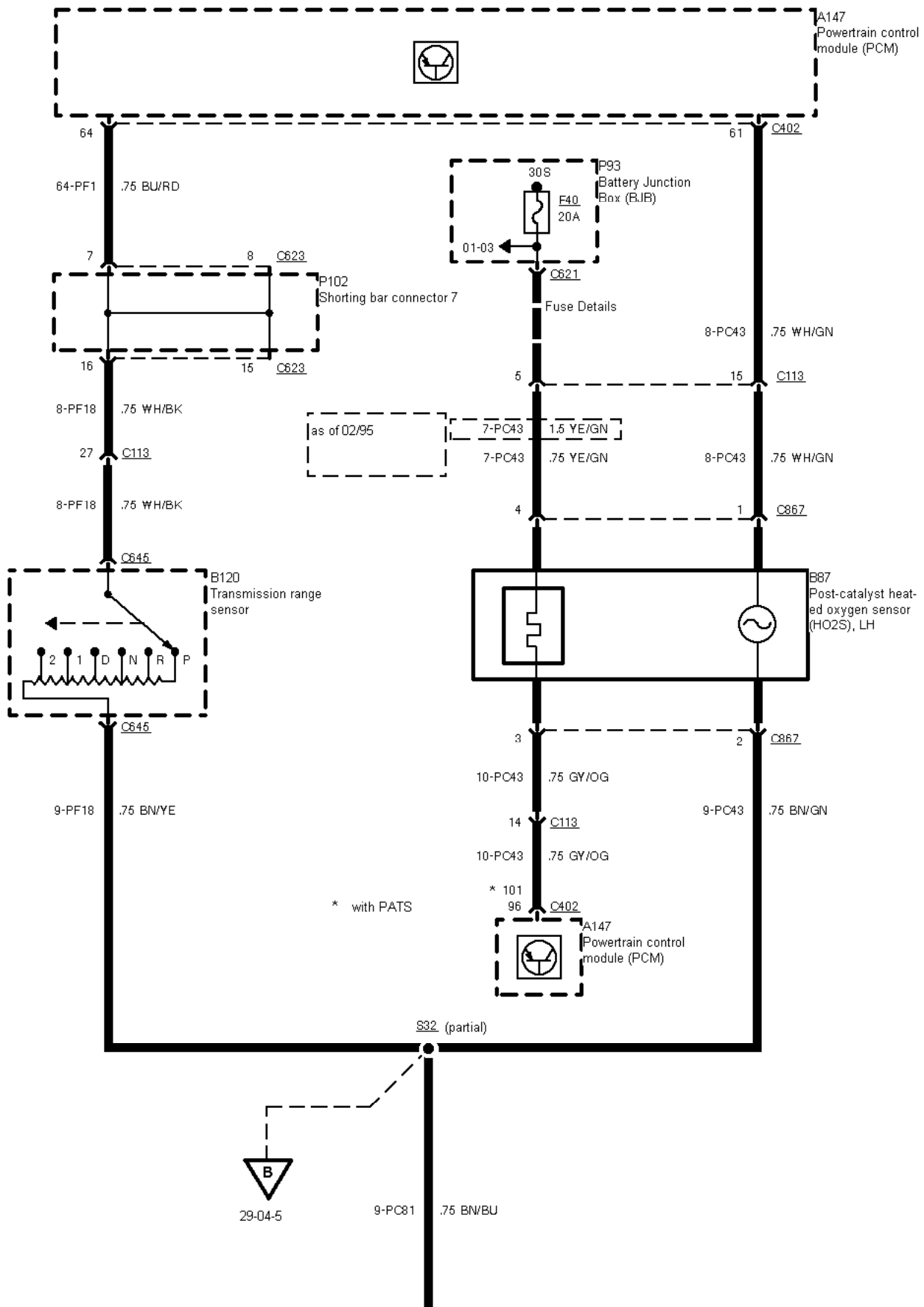



29-04-008 , Engine Control 2,9 I V6 24V EFI , Sensors

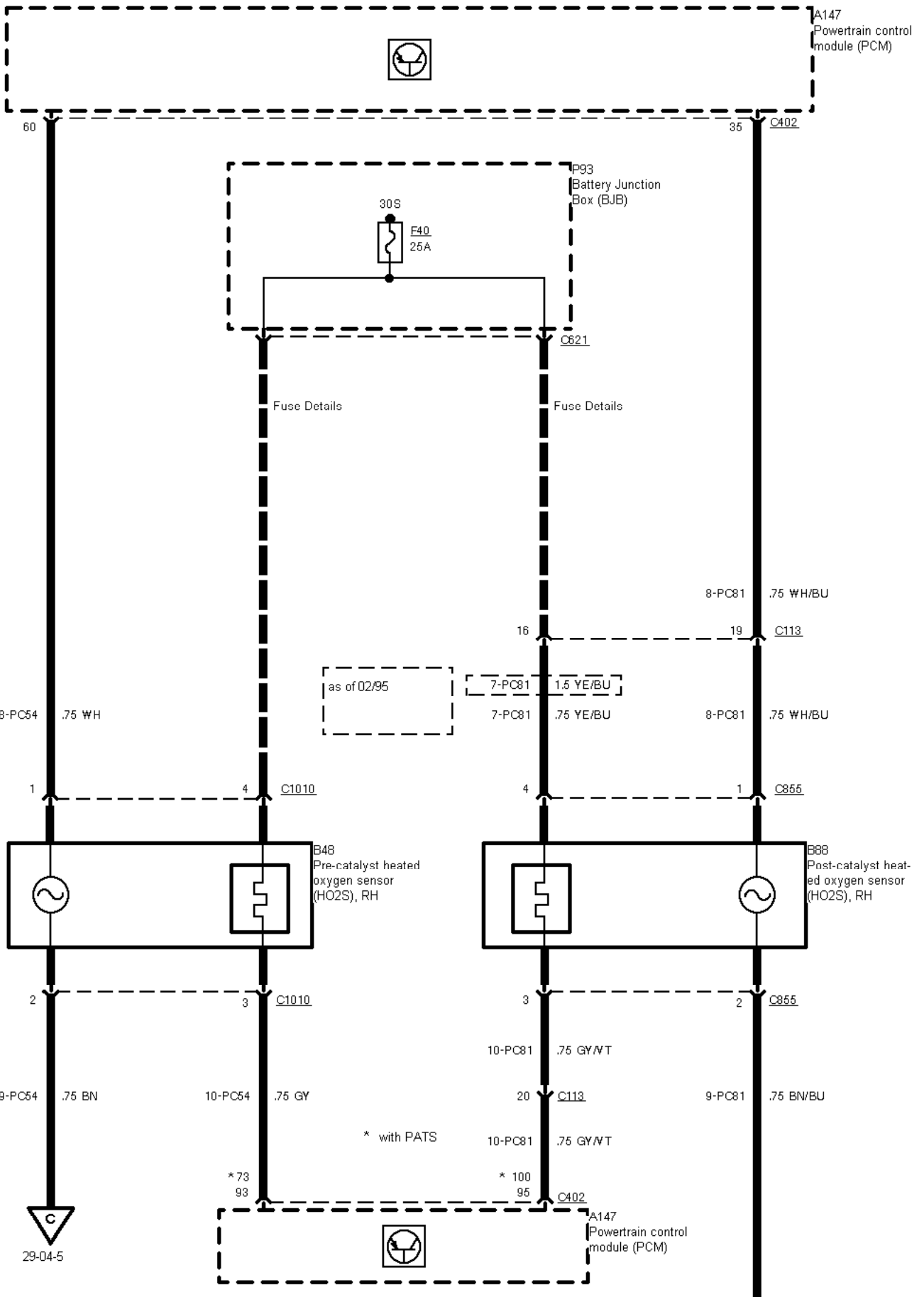



29-04-009 , Engine Control 2,9 I V6 24V EFI

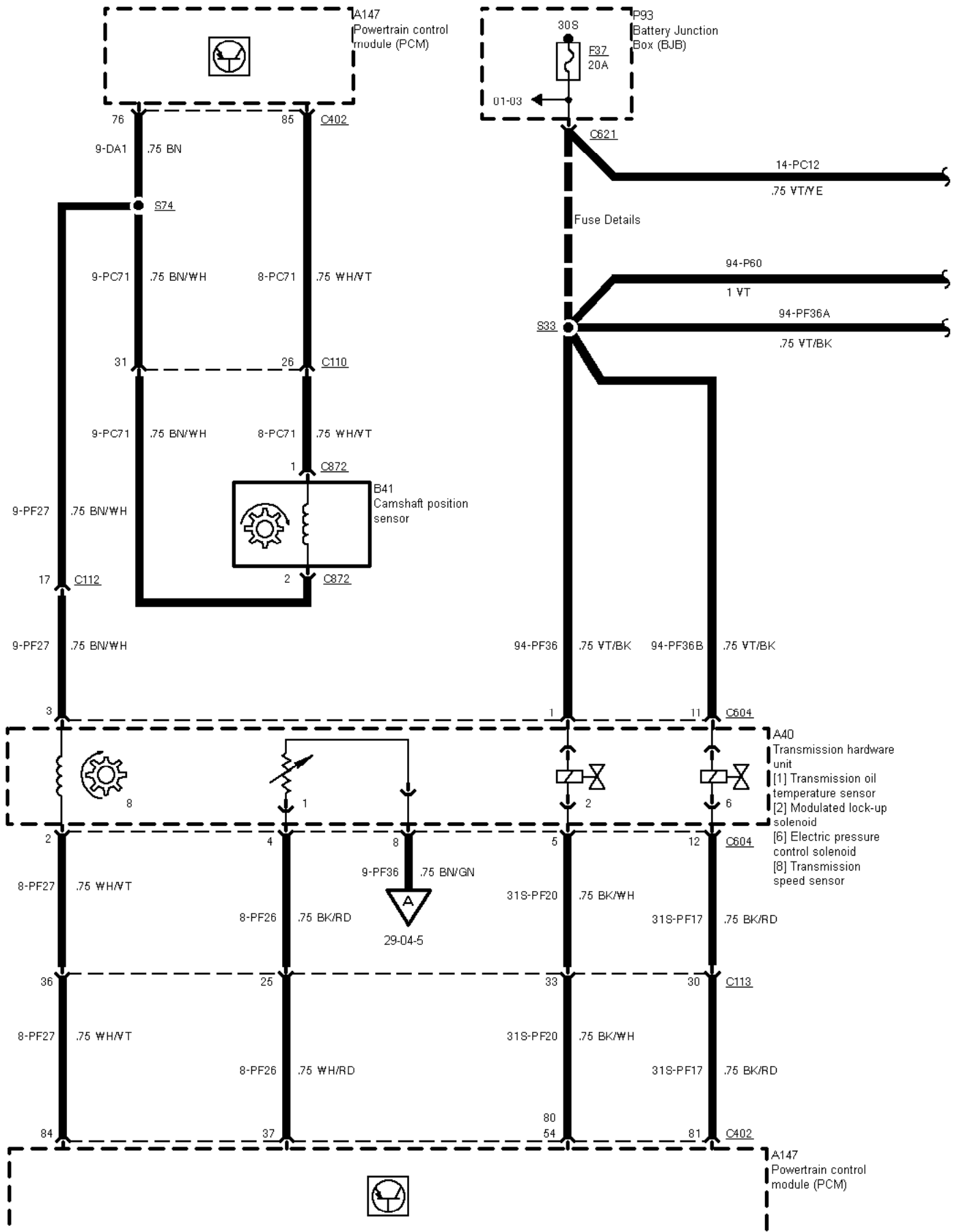

┌-----┐

29-04-010 , Engine Control 2,9 I V6 24V EFI

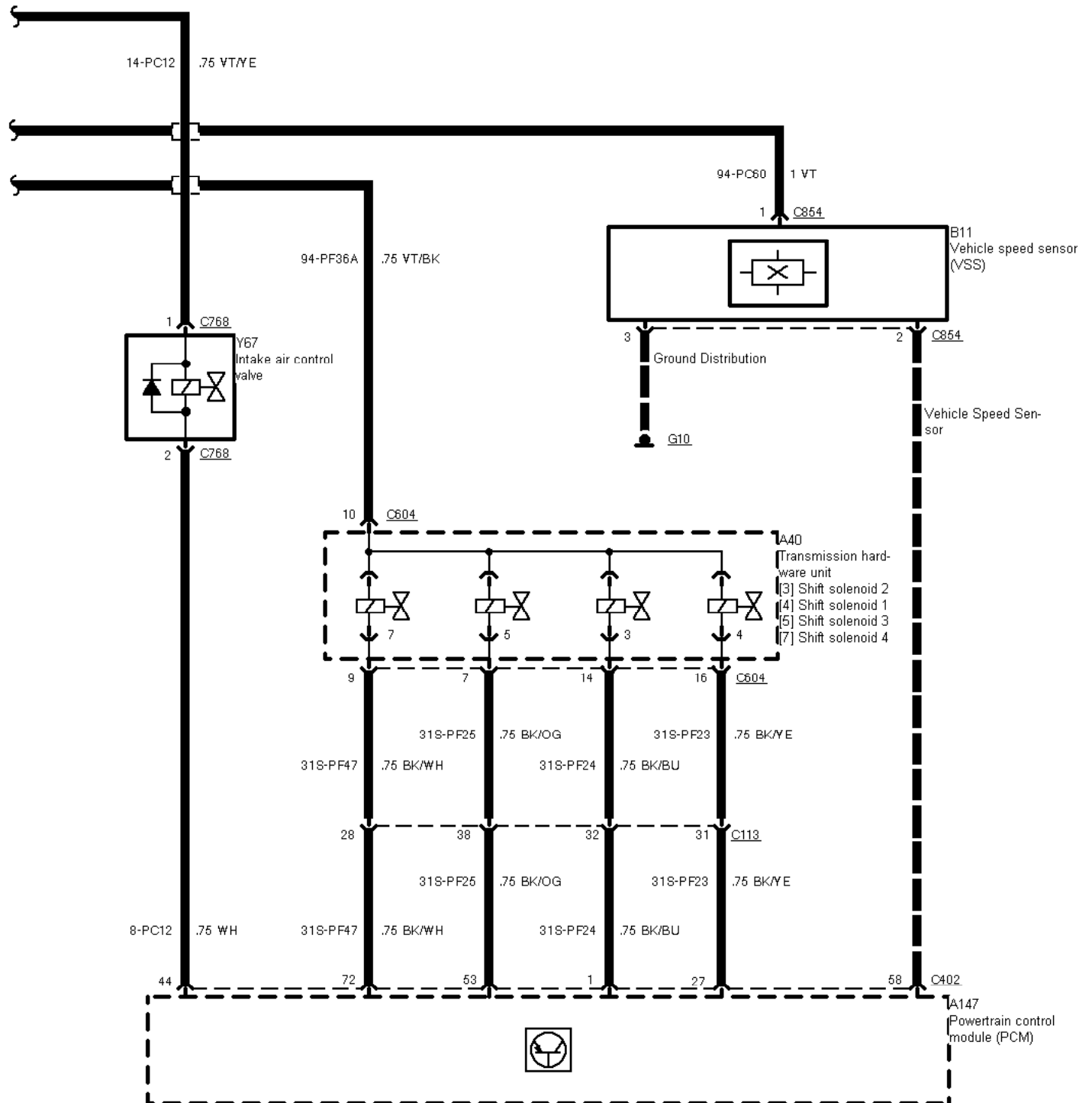

29-04-011 , Engine Control 2,9 I V6 24V EFI

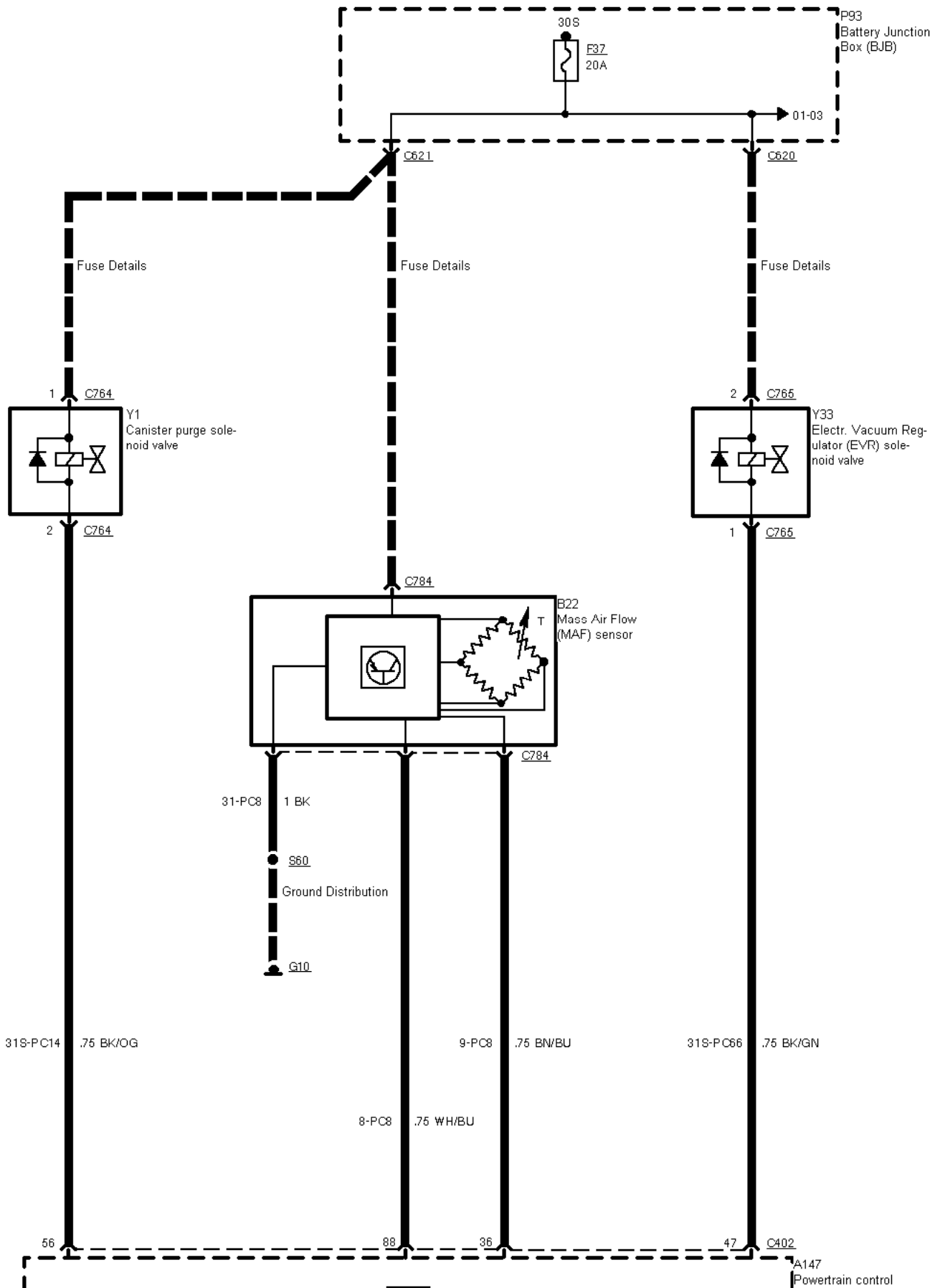



module (PCM)

29-04-012 , Engine Control 2,9 I V6 24V EFI

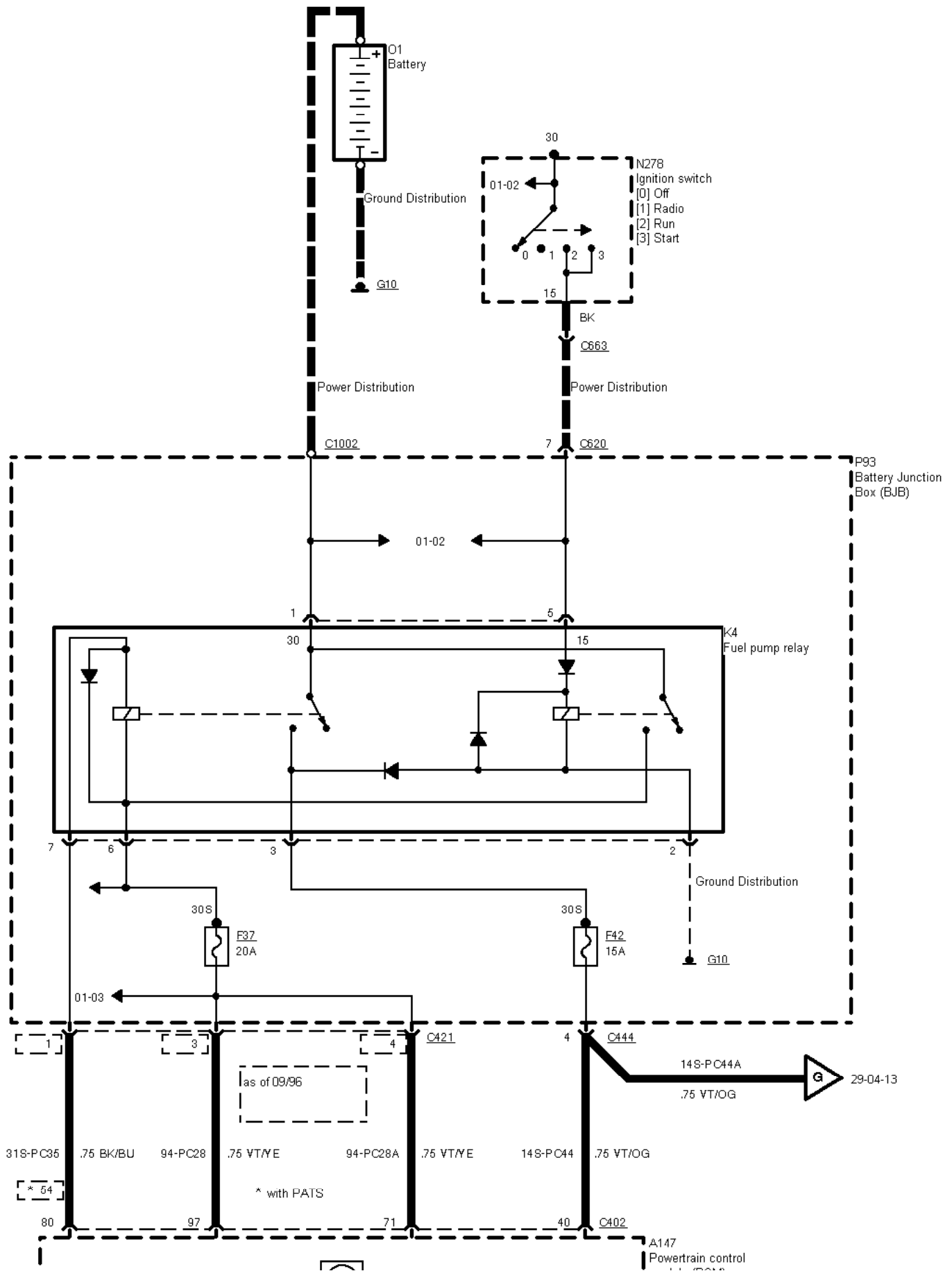

as of 09/96

* with PATS



module (PCM)

29-04-013 , Engine Control 2,9 I V6 24V EFI

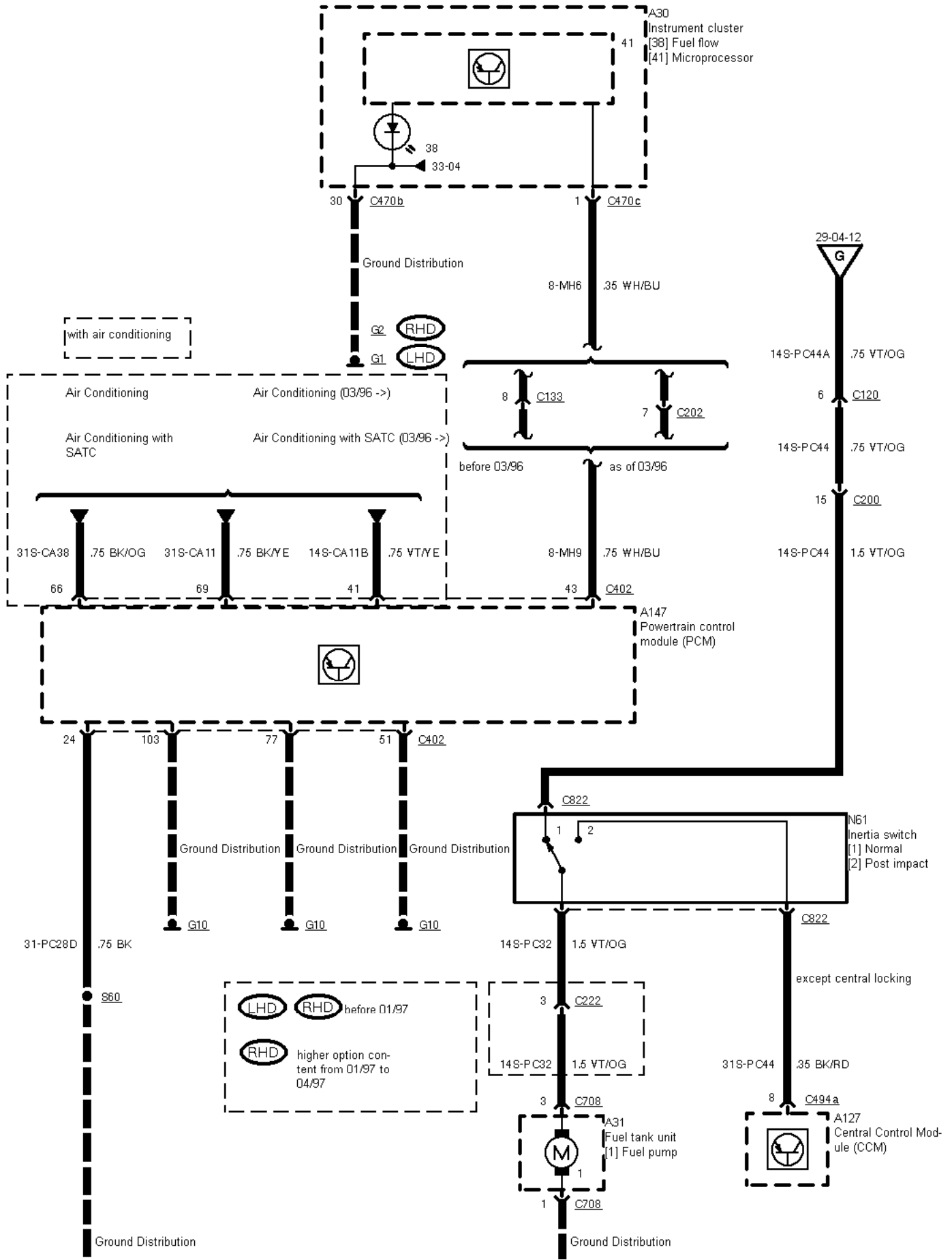



29-04-014 , Engine Control 2,9 I V6 24V EFI , Engine cooling fan

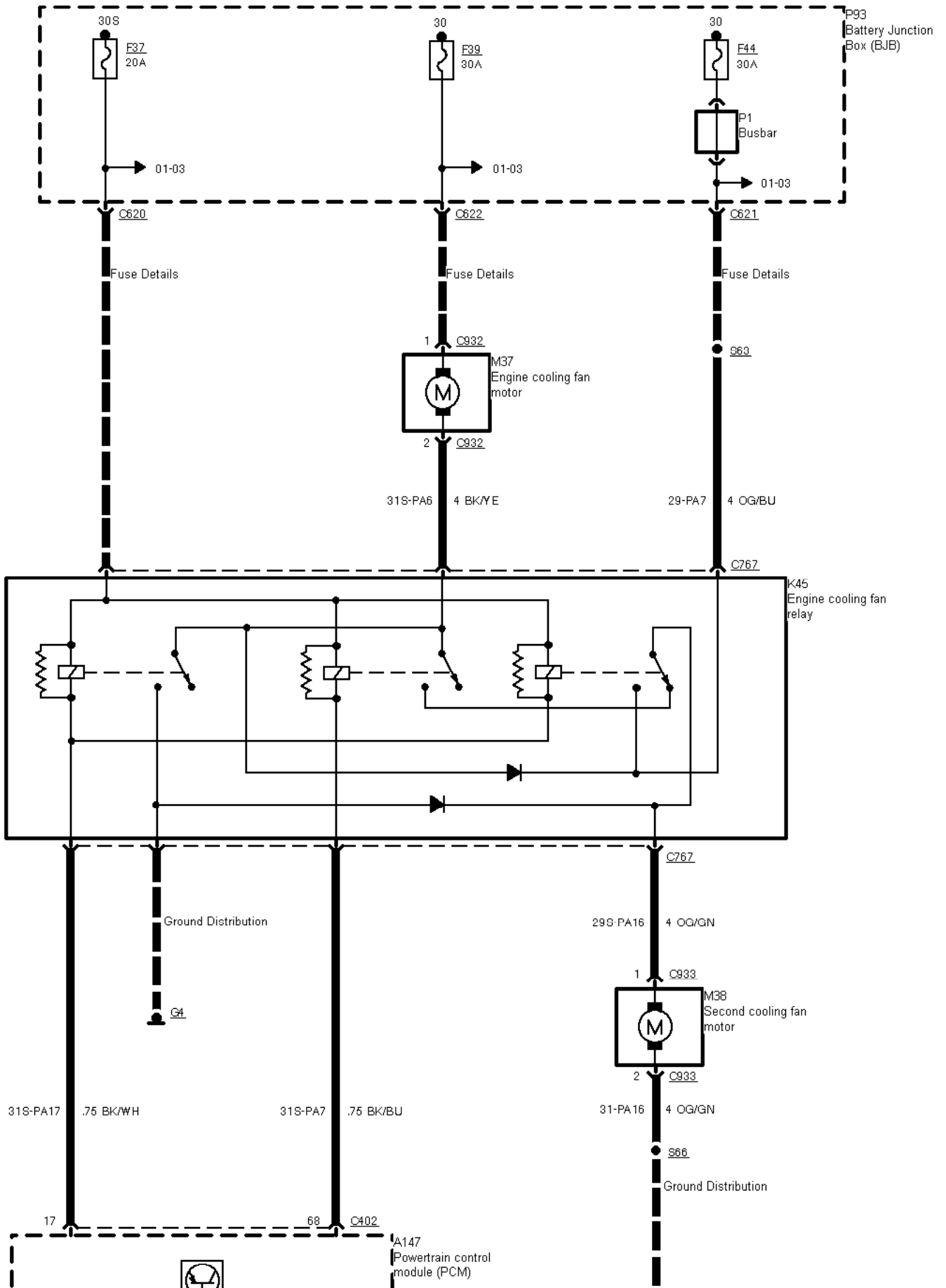

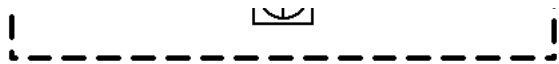

2 Circuit Description
